

62301-2RS1

Dimensions

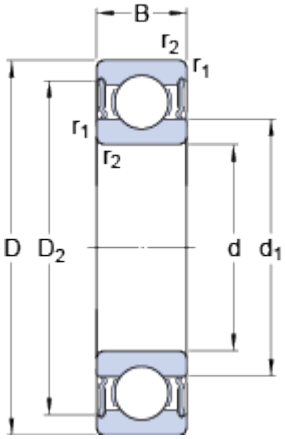

d	12	mm
D	37	mm
B	17	mm
d ₁	≈ 19.5	mm
D ₂	≈ 31.48	mm
r _{1,2}	min. 1	mm

Abutment dimensions

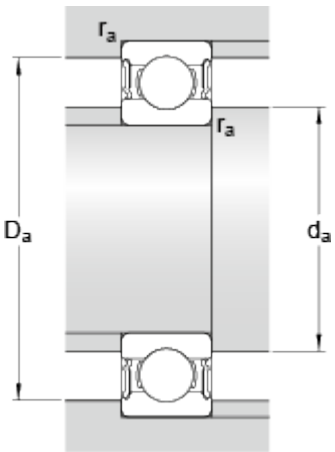

d _a	min. 17.6	mm
d _a	max. 19.4	mm
D _a	max. 31.4	mm
r _a	max. 1	mm

Calculation data

Basic dynamic load rating	C	9.75	kN
Basic static load rating	C ₀	4.15	kN
Fatigue load limit	P _u	0.176	kN
Limiting speed		14000	r/min
Calculation factor	k _r	0.03	
Calculation factor	f ₀	11	

Mass

Mass bearing		0.07	kg
--------------	--	------	----