

62202-2RS1

Dimensions

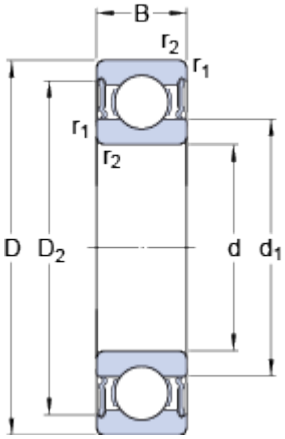

d	15	mm
D	35	mm
B	14	mm
d ₁	≈ 21.7	mm
D ₂	≈ 30.35	mm
r _{1,2}	min. 0.6	mm

Abutment dimensions

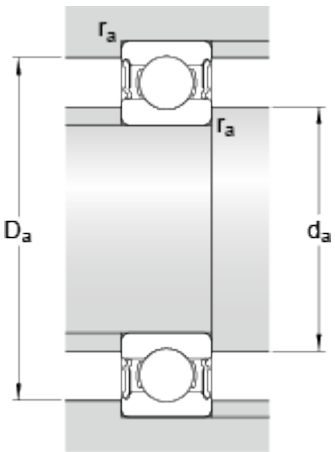

d _a	min. 19.2	mm
d _a	max. 21.6	mm
D _a	max. 30.8	mm
r _a	max. 0.6	mm

Calculation data

Basic dynamic load rating	C	7.8	kN
Basic static load rating	C ₀	3.75	kN
Fatigue load limit	P _u	0.16	kN
Limiting speed		13000	r/min
Calculation factor	k _r	0.025	
Calculation factor	f ₀	13	

Mass

Mass bearing	0.054	kg
--------------	-------	----