

6211

Popular item
SKF Explorer

Dimensions

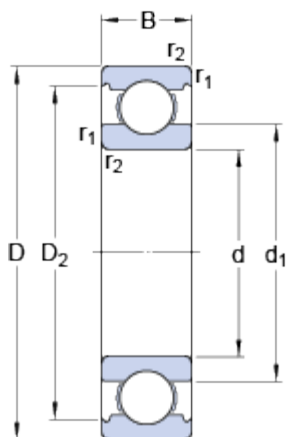

d	55	mm
D	100	mm
B	21	mm
d ₁	≈ 69.06	mm
D ₂	≈ 89.4	mm
r _{1,2}	min. 1.5	mm

Abutment dimensions

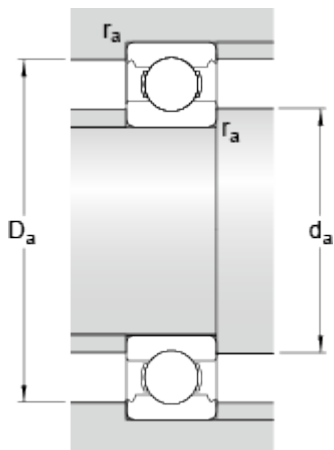

d _a	min. 64	mm
D _a	max. 91	mm
r _a	max. 1.5	mm

Calculation data

Basic dynamic load rating	C	46.2	kN
Basic static load rating	C ₀	29	kN
Fatigue load limit	P _u	1.25	kN
Reference speed		14000	r/min
Limiting speed		9000	r/min
Calculation factor	k _r	0.025	
Calculation factor	f ₀	14.3	

Mass

Mass bearing	0.61	kg
--------------	------	----