

6313

Popular item
SKF Explorer

Dimensions

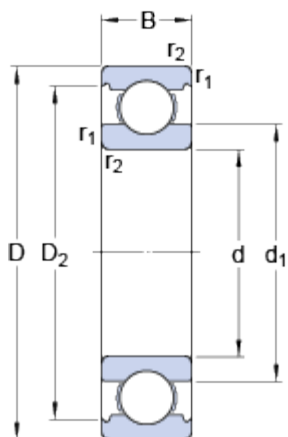

d	65	mm
D	140	mm
B	33	mm
d ₁	≈ 88.35	mm
D ₂	≈ 121.3	mm
r _{1,2}	min. 2.1	mm

Abutment dimensions

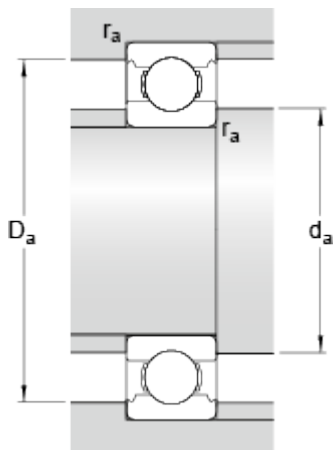

d _a	min. 77	mm
D _a	max. 128	mm
r _a	max. 2	mm

Calculation data

Basic dynamic load rating	C	97.5	kN
Basic static load rating	C ₀	60	kN
Fatigue load limit	P _u	2.5	kN
Reference speed		10000	r/min
Limiting speed		6700	r/min
Calculation factor	k _r	0.03	
Calculation factor	f ₀	13.2	

Mass

Mass bearing	2.11	kg
--------------	------	----